



# P2.5 Indoor Full-color LED Display

(320×160)



V1.0.0

# Catalogue

<b>Chapter 1</b>	<b>Product Introduction</b> .....	<b>1</b>
<b>Chapter 2</b>	<b>Appearance Structure</b> .....	<b>2</b>
2.1	Appearance Picture .....	2
2.2	Technical Parameter .....	2
2.3	Packing List .....	3
<b>Chapter 3</b>	<b>Interface Definition</b> .....	<b>3</b>
<b>Chapter 4</b>	<b>Installation</b> .....	<b>4</b>
4.1	Kit Installation .....	4
4.2	Display Installation.....	5
4.2.1	Diagram for Cable Connection .....	5
4.2.2	Networking Introduction .....	6
4.2.3	Installation Method .....	7
<b>Chapter 5</b>	<b>User Manual</b> .....	<b>8</b>
<b>Chapter 6</b>	<b>Acceptance Request and Method</b> .....	<b>9</b>

# Chapter 1 Product Introduction

- **High refresh、 High gray scale**

The refresh rate can reach more than 3840Hz, the gray scale is 12-14 bit, the display picture is fine and true, the brightness is stable and uniform, there is no flicker and graininess.

- **Driving solutions**

Exploits precise current regulation technology, with both channel-to-channel error and chip-to-chip error less than  $\pm 2.0\%$ .

Enhancement: Non-uniformity at low gray scale, Color shift, low gray mosaics.

Elimination high contrast coupling an color-cast between modules.

- **High viewing angle and high contrast**

It is to adopt red, green and blue SMD2121 LED chips, nice conformity, contrast ratio can be up to 4000:1, visual angle can be up to above  $140^\circ$  , high reliability, long lifespan.

## Chapter 2 Appearance Structure

### 2.1 Appearance Picture

Picture 2-1 Appearance Picture

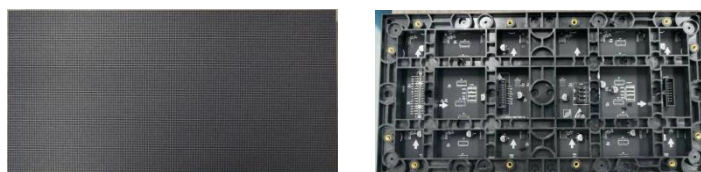

### 2.2 Technical Parameter

Table 2-2 Technical Parameter

Item	Parameter	Ordinary Standard Configuration
Module Parameter	Product Mode	IFS-LIA2.5S-L
	Pixel Composition	SMD2121
	Pixel Pitch (mm)	2.5
	Module Resolution (W×H)	128×64
	Pixel Density (dots/m <sup>2</sup> )	1600000
	Module Size (mm)	320×160
	Module Weight (kg)	0.42±0.01
	Module Input Voltage (V)	4.2-5.0
	Max Current for Module (A)	≤4
	Max Power Consumption for Module (W)	≤20
Optical Parameter	Max.Brightness (nits)	>500
	Visual Angle (H/V)	140° /130°
	Brightness / Colorful Evenness	≥95%
	Contrast Ratio	3000:1
Performance Parameter	Frequency (Hz)	≥50/60
	Driving Method	Constant Current, 1/64 Scanning
	Refresh Ratio (Hz)	3840
	Color Processor (bit)	12-14
	Work/Humidity temperature (°C/RH)	-10°C- 40°C / 10%-65%RH
	Storage Temperature/Humidity (°C/RH)	-20°C- 60°C / 10%-65%RH
*We would not provide additional notification if the product information has any update, our company do not take any obligation because of this.		

## 2.3 Packing List

Table 2-3 Packing List

Packing List	Qty	Unit
LED Module	40	pcs
Power cable	20	pcs
Flat cable	40	pcs

## Chapter 3 Interface Definition

Picture3-1 Interface Picture (HUB 75)

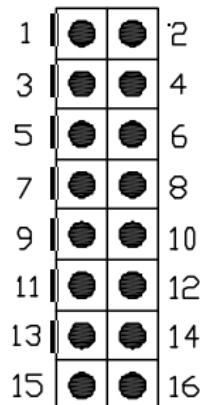

Table 3-2 Interface Definition

Pin	Signal	Function	Pin	Signal	Function
1	R1	Red Data Signal	2	G1	Green Data Signal
3	B1	Blue Data Signal	4	GND	Power Ground
5	R2	Red Data Signal	6	G2	Green Data Signal
7	B2	Blue Data Signal	8	GND	Power Ground
9	A	Row Decoding Signal	10	B	Row Decoding Signal
11	C	Row Decoding Signal	12	D	Row Decoding Signal
13	CLK	Clock Signal	14	LAT	Latch Signal
15	OE	Enable Signal	16	GND	Power Ground

# Chapter 4 Installation

## 4.1 Kit Installation

Picture 4-1 Hole Installation Diagram for Kit

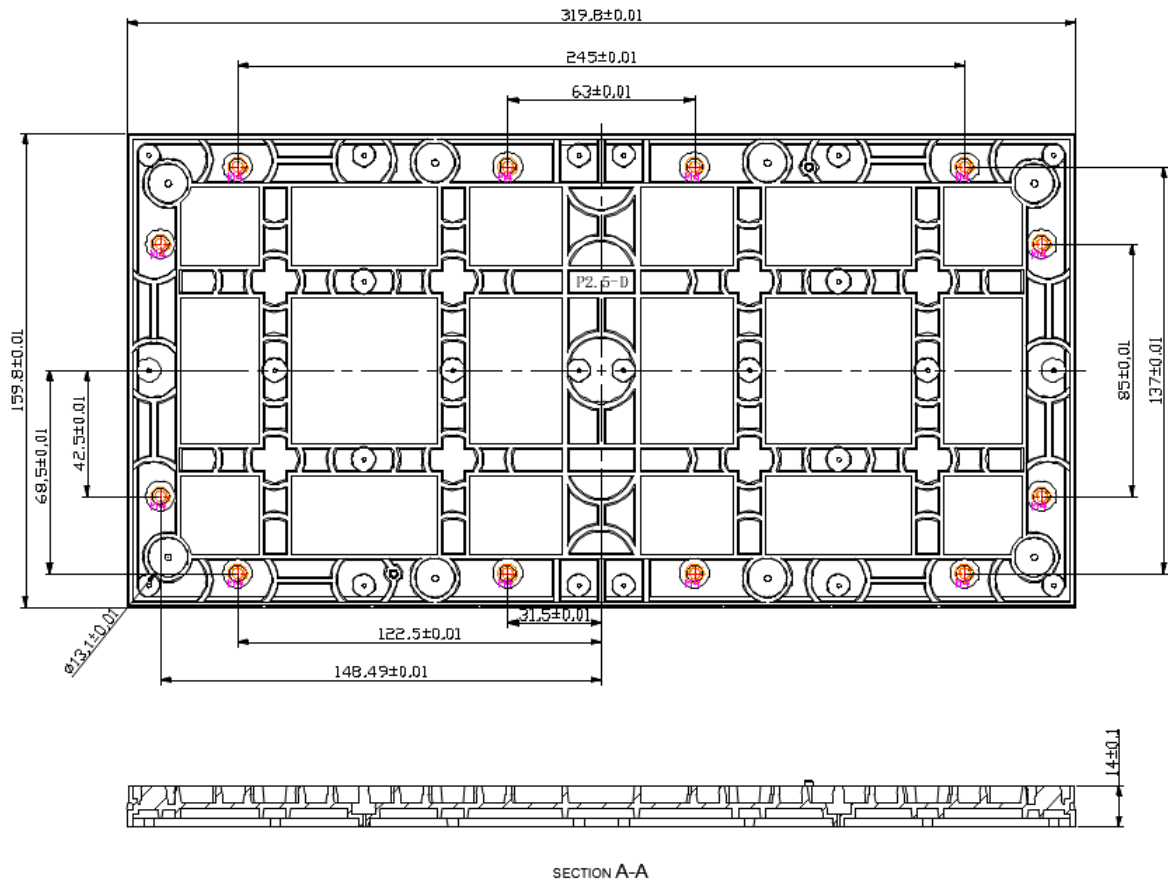

## 4.2 Display Installation

### 4.2.1 Diagram for Cable Connection

Picture 4-2-1 Diagram for Connection

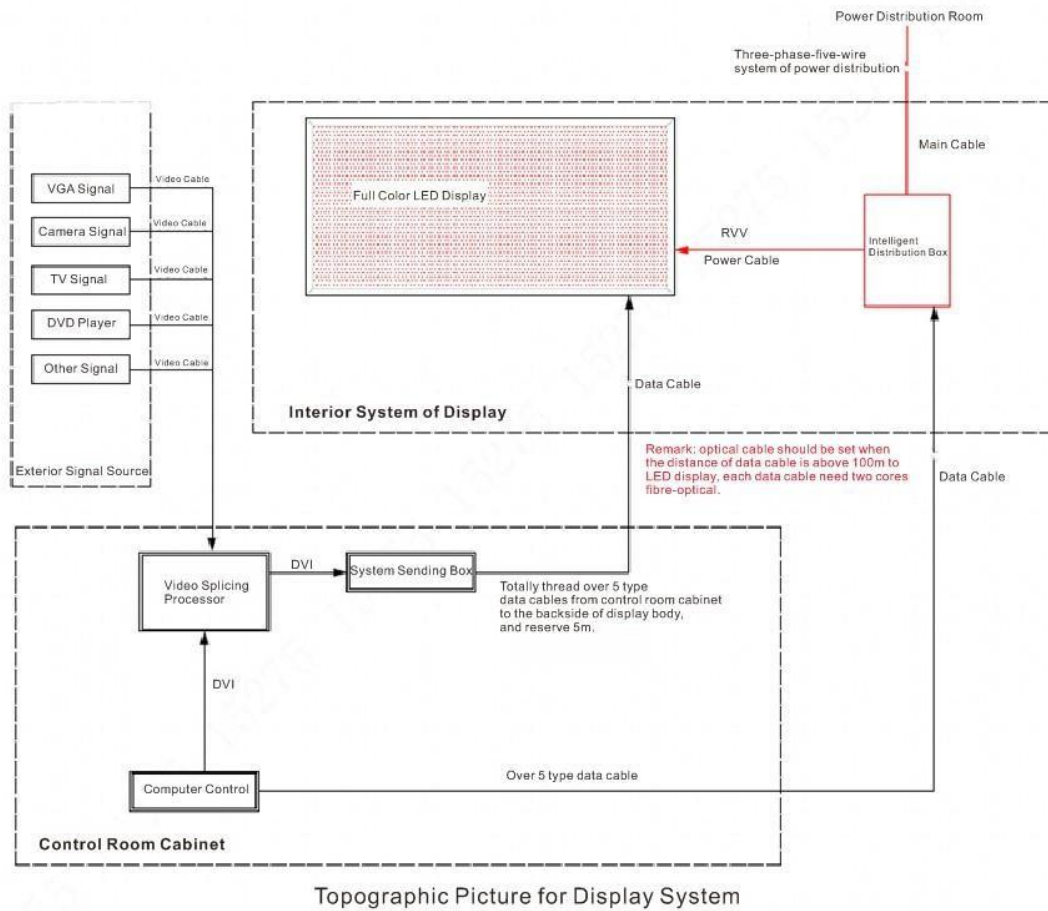

## 4.2.2 Networking Introduction

Picture 4-2-2 Topographic Picture for networking

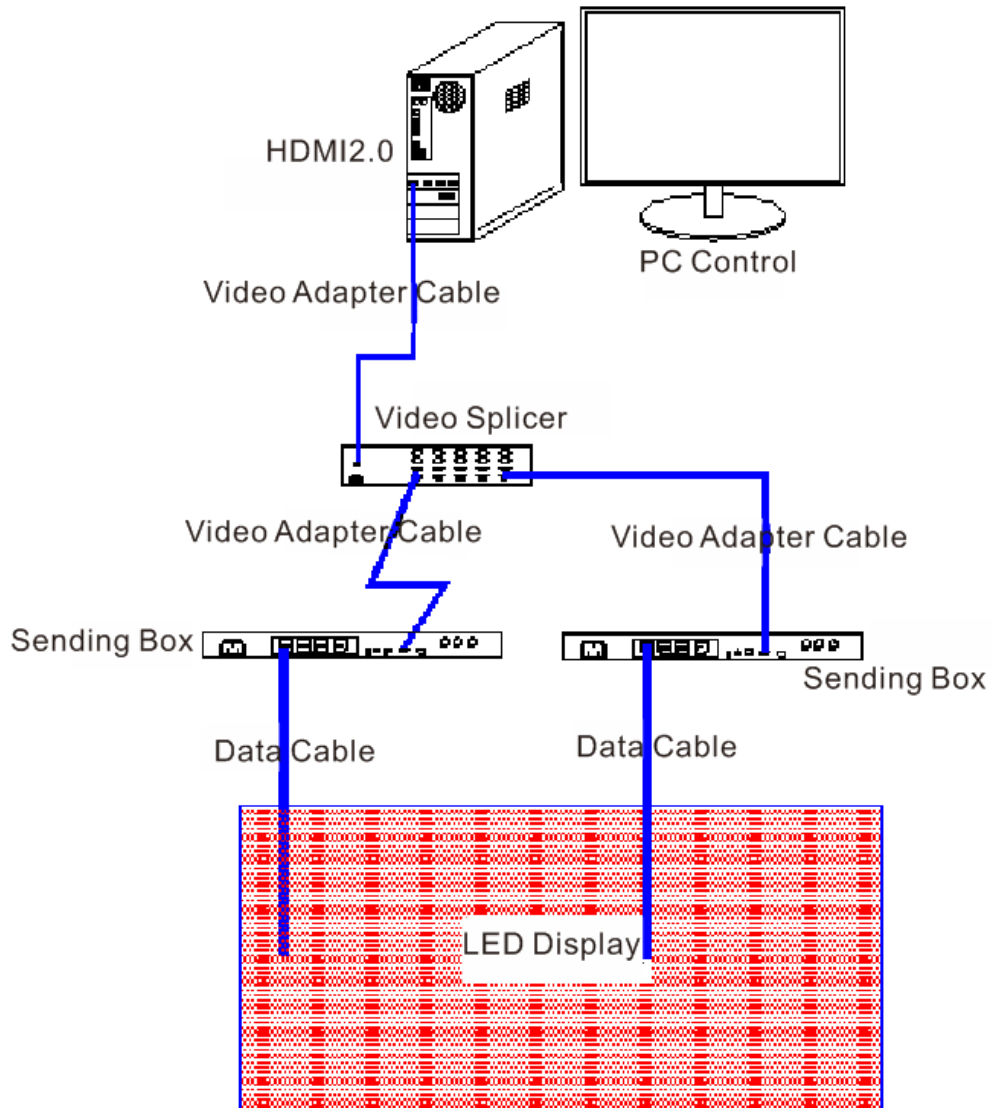

## 4.2.3 Installation Method

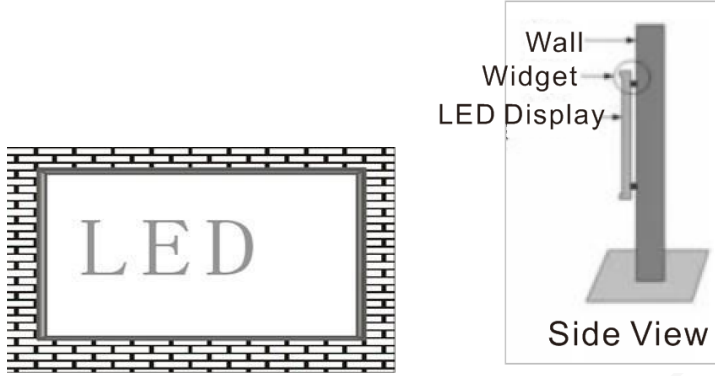
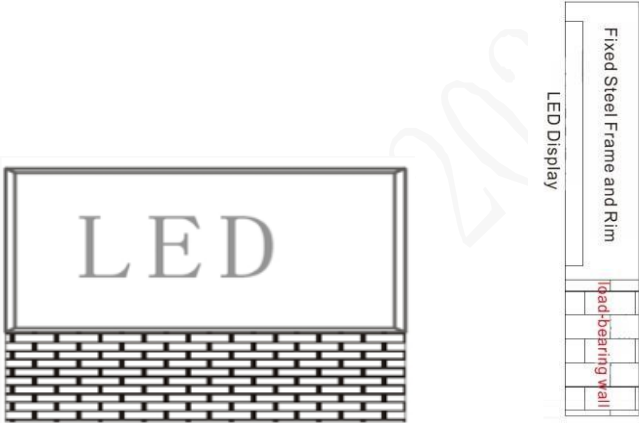
Installation Type	Picture
<p>Wall Mounted Installation</p>	
<p>Floor Mounted Installation</p>	

# Chapter 5 User Manual

Table 5-1 Notification

Item	Notification
Temperature	Keep the work temperature within -10°C~40°C
	Keep the storage temperature within -10°C~30°C
Humidity	Keep the work humidity within 10%RH~65%RH
	Keep the storage humidity within 10%RH~60%RH
Waterproof	Cabinet: IP30; Module: IP30
Dust-proof	Cabinet: IP30; Module: IP30
Anti-Electromagnetic radiation	LED display shouldn't put under the environment where has strong interference by electromagnetic radiation, which would be easy to picture display abnormal.
Electrostatic Prevention	It should be ground connected well for power supply, cabinet, mental cover of display body, the resistance of ground connection<10Ω, to avoid making any damage to electric components.

Item	User Manual
Electrostatic Protection	The installer need wear electrostatic ring and electric gloves, each equipment should take ground connection well when installing.
Connection Type	There are positive and negative electrode silk printed on module, don't allow to reverse connect, and prohibit to connect with AC 220V.
Operate Type	Prohibit to assemble module, cabinet and whole of display under power on, operation should be under power off completely, to protect personal safety; Prohibit anyone to touch when the LED display is working, in case the static electricity which is generated by body to break through LED and other components.
Dismantle and Transportation	Don't allow to throw, push, compress module, to prevent module falling down, to avoid breaking kit, damage LED chips, etc.
Environmental Inspection	It should match temperature and humidity meter for LED display at installation site, to monitor its surrounding environment, so that it can find out if LED display being affected with damp, moisture, etc.
The Usage of LED display	The environmental humidity should be 10%RH~65%RH, it is suggested to turn on LED display one time each day, normal to use above 4 hours each time, to remove its damp.
	When the environmental humidity is above 65%RH, it should make dehumidification to environment, and it is suggested to work LED display above 8h each day.
	When LED display has not turned on for a long time, it should preheat LED display to remove moisture before use, to avoid damage LED because of damp, the specific method: 20% brightness to work for 2h, 40% brightness to work for 2h, 60% brightness to work for 2h, 80% brightness to work for 2h, 100% brightness to work for 2h, by this to gradually increase its brightness.

## Chapter 6 Acceptance Request and Method

Table 6-1 Acceptance Request and Method for LED display

Item	Acceptance Request and Method
Brightness of LED Display	Switch LED display to work as full brightness, use light-gun to measure the brightness of LED display within 10 minutes. When measuring its brightness, the light-gun need be vertical to LED display, to adjust the distance of light-gun and LED display, ensure the view window, black area, cover above 16 pixels, adjust focal length, to ensure LED chip being able to clearly view in eyepiece, then measure and record brightness data.
Visual Angle	The one should stand on the angle of $140^\circ$ , bottom angle $65^\circ$ to LED display when making measurement, it is requested that LED display should not have obvious the problem of dark block.
<p>The diagram consists of two parts. The left part shows a horizontal rectangle labeled 'LED Display'. A horizontal dashed line passes through the center of the display. Below the display, two lines labeled 'Sight Line' originate from a single point and extend upwards to the bottom corners of the display, forming an angle of <math>140^\circ</math> at that point. The right part shows a vertical rectangle labeled 'LED Display'. A horizontal dashed line extends from the top edge of the display to the right. A line labeled 'Sight Line' originates from the top-right corner of the display and extends downwards and to the right, forming an angle of <math>65^\circ</math> with the horizontal dashed line.</p>	